

# Entro<sup>®</sup> V DV82

(300 m<sup>3</sup>/h)

KIT SUITABLE FOR DWELLING FLOOR AREA UP TO 184 m<sup>2</sup>



RESIDENTIAL FANS



HEAT RECOVERY



COMMERCIAL FANS



DUCTING ACCESSORIES



# MORE THAN 60 YEARS OF EXPERIENCE

Founded in 1955, Airflow has grown from one man's expertise in fan design and air flow measurement into a thriving international group. Renowned for its innovative approach to new product development and air movement techniques, Airflow can offer you a variety of ventilation solutions to suit your needs.

With our headquarters in High Wycombe, Airflow has subsidiaries in Germany and the Czech Republic and has global distributors from Norway to New Zealand.

Understanding the requirements of our customer enables Airflow's knowledgeable and committed staff to continually develop new and innovative products that raise standards and provide long term, reliable ventilation solutions.



## UNITED KINGDOM

High Wycombe (Head Office)

Our founder started the business in 1955, just one mile from the current site, which has been Airflow's headquarters since 1960, co-ordinating our global activities.



## GERMANY

Airflow has been serving ventilation products and air measurement devices to the German and European markets for over 50 years. Operating near Cologne, Airflow Germany has their own customer service, sales and technical sales teams.



## CZECH REPUBLIC

Founded in Prague over 20 years ago, the Airflow Czech Republic team offer sales and servicing of ventilation products for the Eastern European market.



# COMPLETE VENTILATION SYSTEM FROM AIRFLOW, ENTRO-V RANGE



A range of SAP PCDB (Product Characteristics Data Base) listed Mechanical Ventilation with Heat Recovery units for residential applications. These top or side entry units are made from galvanised steel, white powder-coated casing with 20 mm EPP insulation that provides significant insulation, a great level of air tightness, thermal efficiency, and sound absorption.

Complete with 100% summer bypass and a number of optional accessories, Entro-V offers the installer a huge range of installation options to suit their ventilation needs.

## Entro<sup>®</sup>V DV82



The Entro-V ventilation units with heat recovery are available for a large variety of building sizes. The medium unit size in the range, Entro-V DV82, can supply up to 300 m<sup>3</sup>/h (83.3 l/s) and can be installed in vertical mounting positions, on the wall or on the floor. Hanging brackets, screws and feet are supplied with the unit. Also, the unit has interchangeability of spigots position from top to the sides.

In addition to high quality individual ventilation components, an overall integrated concept is essential to a well-functioning ventilation system. Airflow offers the ideal ventilation system solutions and guarantees easy design, safe installations, and maximum efficiency.



## WELCOME TO YOUR NEW FUTURE HOME

FITTED WITH AN AIRFLOW VENTILATION SYSTEM WITH HEAT RECOVERY, YOU WILL EXPERIENCE A HEALTHY, FEEL-GOOD AMBIANCE AT ALL TIMES.

An Airflow MVHR system can provide the required minimum air exchange for your home, regardless of your house size this unit can provide the air needed, creating a pleasant room temperature and draught-free, clean air at all times.

Thanks to the integrated filters and the well-thought-through hygiene concept, a healthy atmosphere is created for the whole family to feel comfortable and even those suffering from allergies can breathe freely. The windows can stay shut, meaning pollen, dust, and road noise stay outside.

The continuously running ventilation system reduces moisture which means effective mould and mildew prevention. This protects the building fabric and therefore the value of your property in the long term. In addition, the heat recovery system reduces your overall energy and heating bill costs – meaning you save and actively contribute to the protection of the environment.



To work out the ideal Entro-V ventilation unit required for this example dwelling size, we need to consider the number, type, and size of habitable and wet rooms and their airflow rates, as specified by the Approved Document Part F of the Building Regulations.

The bill of materials from the ventilation unit to the air distribution products required for this example designed ventilation system can be seen on the following pages.

Room description	Floor	Floor space [m <sup>2</sup> ]	Room volume [m <sup>3</sup> ]	Extract air [m <sup>3</sup> /h]	Supply air [m <sup>3</sup> /h]	Extract air terminals	Air volume per extract terminal [m <sup>3</sup> /h]	No. of duct(s) per extract terminal	Supply air terminals	Air volume per supply air terminal [m <sup>3</sup> /h]	No. of duct(s) per supply air terminal
<b>Kitchen</b>	Ground Floor	11.5	27.6	48	-	1	Terminal 1: 48	Duct(s) 1: 2	-	-	-
<b>W.C.</b>	Ground Floor	1.8	4.2	24	-	1	Terminal 1: 24	Duct(s) 1: 1	-	-	-
<b>Utility</b>	Ground Floor	3.3	7.87	41	-	1	Terminal 1: 41	Duct(s) 1: 2	-	-	-
<b>Dining</b>	Ground Floor	11.5	27.6	-	24	-	-	-	1	Terminal 1: 24	Duct(s) 1: 1
<b>Family room</b>	Ground Floor	11.6	27.77	-	24	-	-	-	1	Terminal 1: 24	Duct(s) 1: 1
<b>Living room</b>	Ground Floor	21.8	52.25	-	24	-	-	-	1	Terminal 1: 24	Duct(s) 1: 1
<b>Hall+Cupboards</b>	Ground Floor	12.5	30.05	-	-	-	-	-	-	-	-
<b>Bathroom</b>	First Floor	6.5	15.53	24	-	1	Terminal 1: 24	Duct(s) 1: 1	-	-	-
<b>Bed 1 En-suite</b>	First Floor	4.2	9.98	24	-	1	Terminal 1: 24	Duct(s) 1: 1	-	-	-
<b>Bed 2 En-suite</b>	First Floor	3	7.1	24	-	1	Terminal 1: 24	Duct(s) 1: 1	-	-	-
<b>Bed 1</b>	First Floor	12	28.78	-	24	-	-	-	1	Terminal 1: 24	Duct(s) 1: 1
<b>Bed 1 Dressing</b>	First Floor	5.9	14.23	-	24	-	-	-	1	Terminal 1: 24	Duct(s) 1: 1
<b>Bed 2</b>	First Floor	11.6	27.89	-	21	-	-	-	1	Terminal 1: 21	Duct(s) 1: 1
<b>Bed 3</b>	First Floor	10.2	24.55	-	24	-	-	-	1	Terminal 1: 24	Duct(s) 1: 1
<b>Bed 4</b>	First Floor	8.7	20.9	-	20	-	-	-	1	Terminal 1: 20	Duct(s) 1: 1
<b>Landing+Cupb</b>	First Floor	11.8	28.37	-	-	-	-	-	-	-	-
<b>Total:</b>		147.9	354.67	185	185	6	185	8	8	185	8

Minimum ventilation rate\*: 160 m<sup>3</sup>/h

Maximum ventilation rate\*: 185 m<sup>3</sup>/h

Recommended ventilation rate: 172 m<sup>3</sup>/h @ medium fan speed

Calculated air exchange rate: 0.49

\* according to Building Regulations Part F, 2022

Manually adjusted ventilation rates:

Total adjusted extract air: 185 m<sup>3</sup>/h @ medium fan speed

Total adjusted supply air: 185 m<sup>3</sup>/h @ medium fan speed

Air exchange rate: 0.52

The table above provides you with the following information:

1. How many terminals must be installed for the particular room.
2. Extract or supply air terminals identification.
3. How many ducts should be installed and connected to the respective terminal.
4. Which air volume should flow through the particular terminal when the ventilation system is running at medium fan speed.



### AIR DISTRIBUTION CHART

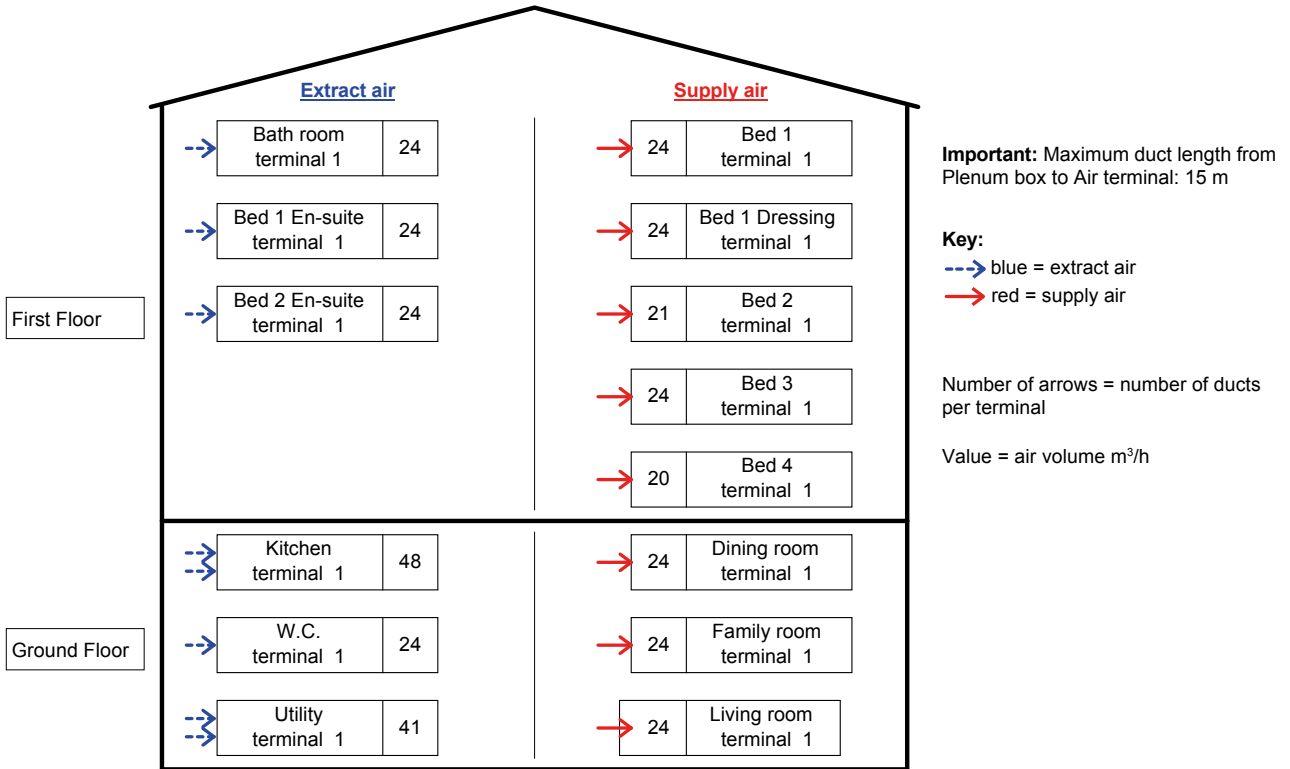

### DUCT WORK PLAN

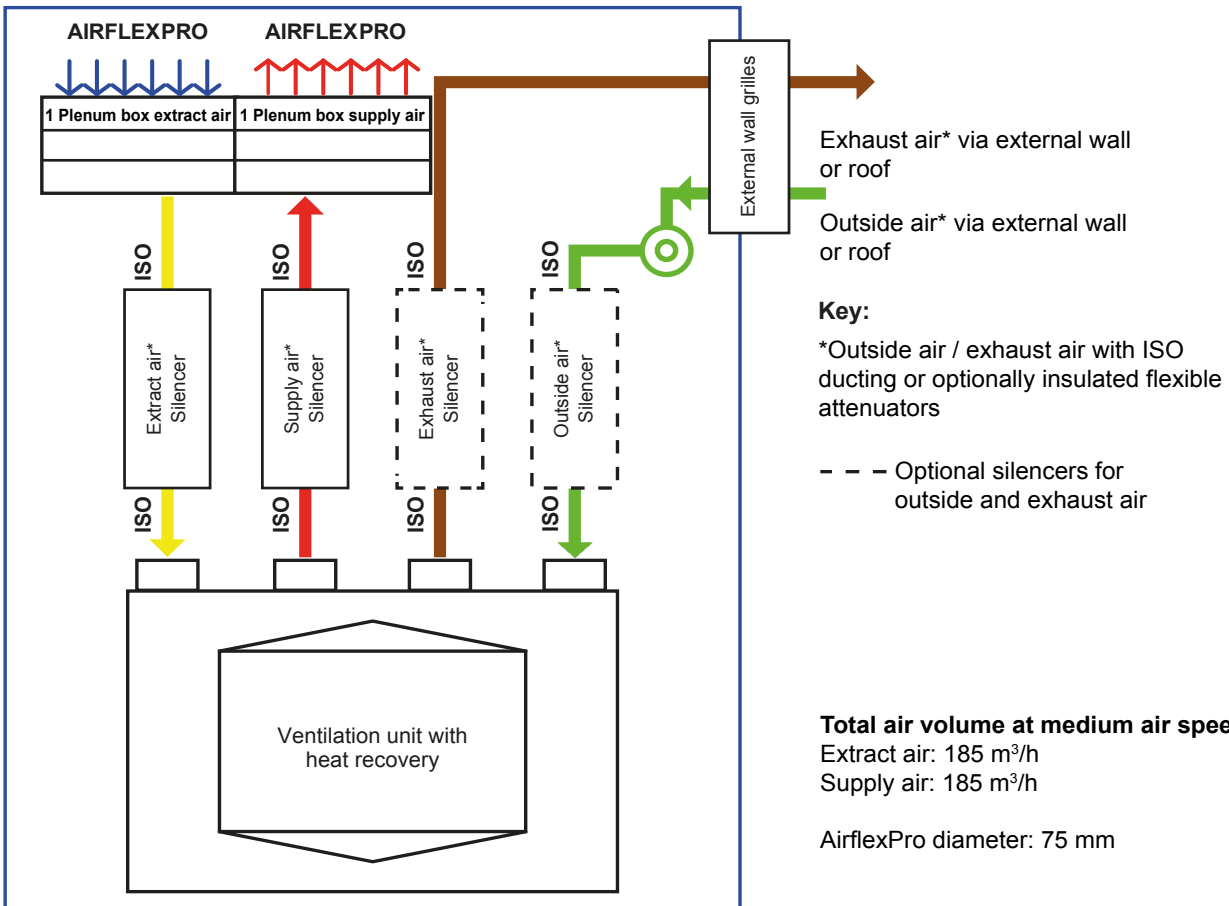

# EXAMPLE BUILDING SPECIFICATION AND FLOOR PLANS

Type: Detached house

Living space: 147 m<sup>2</sup> - Levels: 2 - Bedrooms: 4 - Habitable rooms: 8 - Wet rooms: 6

Note: blue and red is for illustration purposes only.

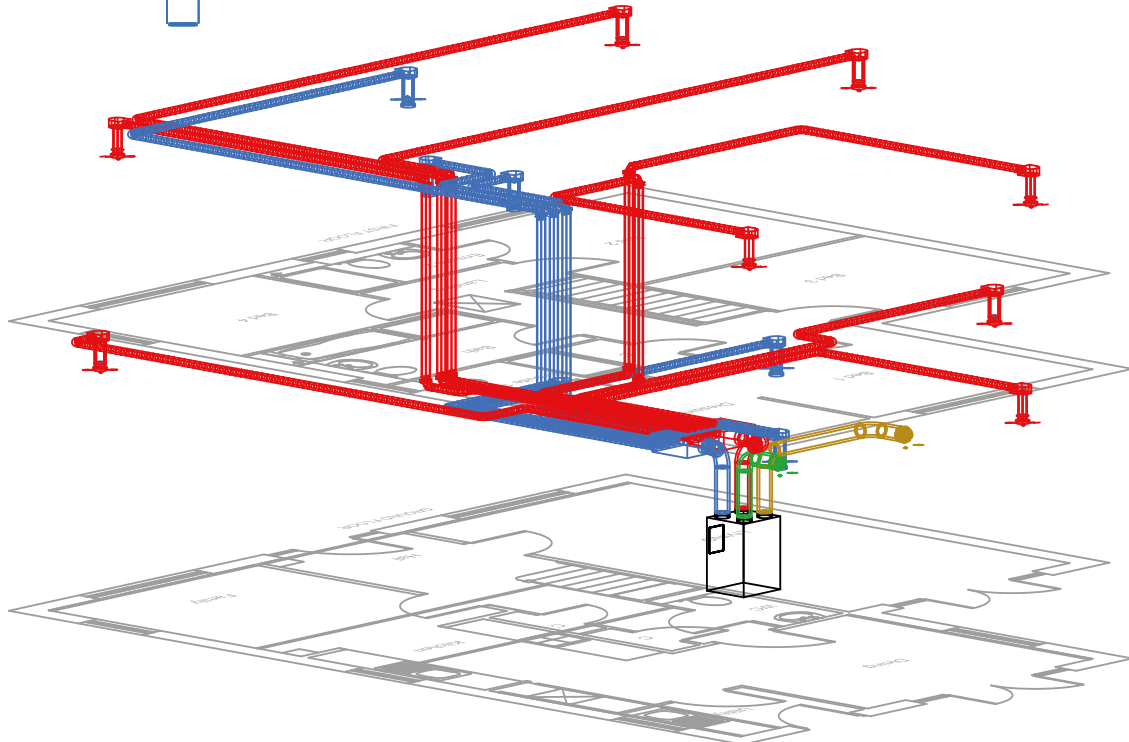
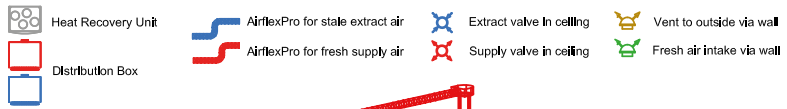
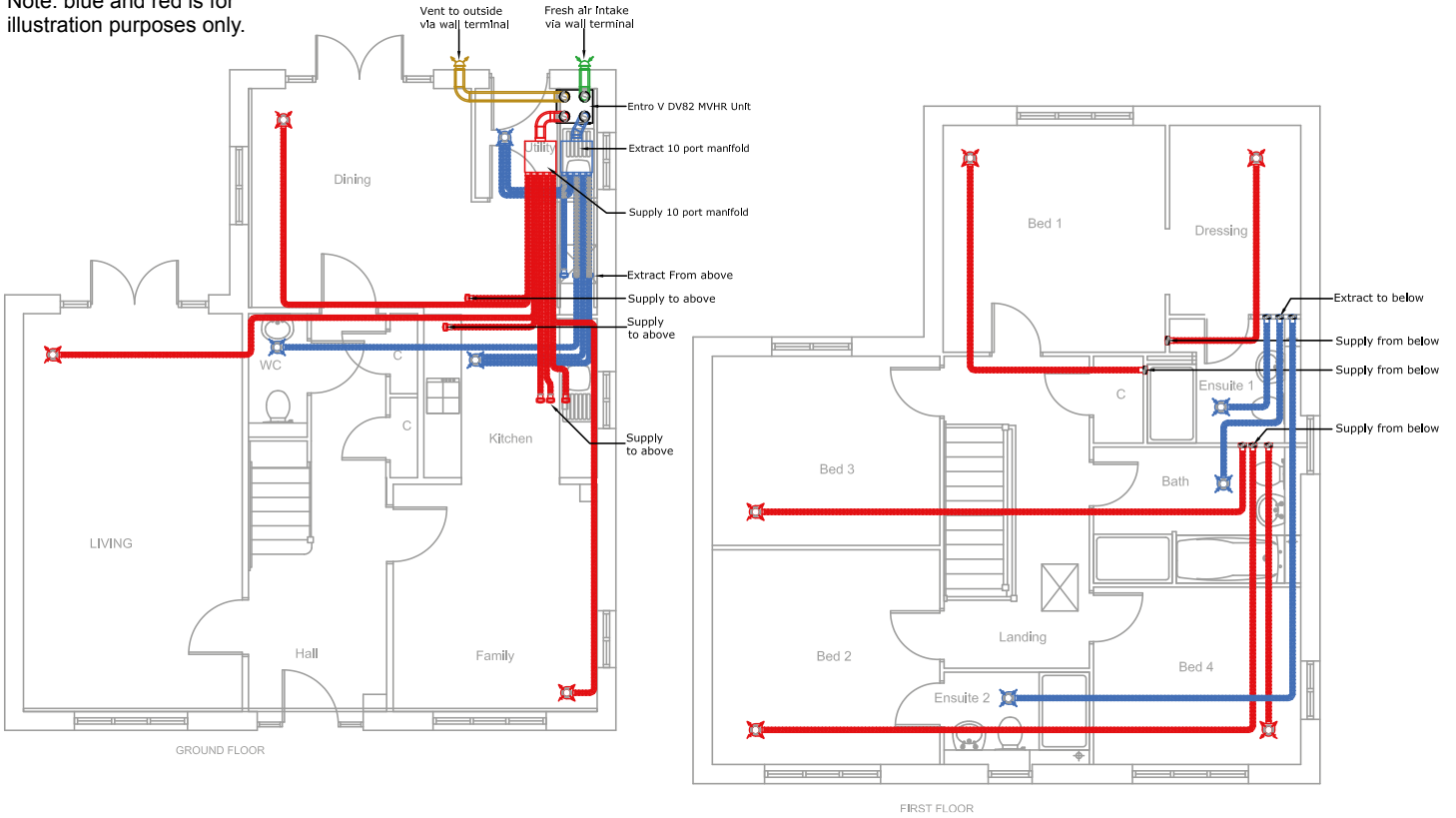

# Entro<sup>®</sup>V DV82

Mechanical Ventilation with Heat Recovery



## KEY FEATURES

- 300 m<sup>3</sup>/h (83.3 l/s) maximum air flow rate @100Pa
- Domestic and residential heat recovery ventilation
- Thermal efficiency capabilities of up to 85%
- 2x ISO ePM Coarse 55% (G4) filters as standard with an extra supply air filter location for an optional ISO ePM1 60% (F7) - ISO 16890 compliant
- Compact design
- Suitable for vertical mounting on the wall or floor (accessories included as standard)
- Easy filter change with no tools needed
- Choice of spigot locations (top or side entry or combination).
- Suitable for left and right hand configurations
- SAP eligible
- 2 year warranty+

## Duplexvent DV82 Entro-V

The DV82 Entro-V is a compact and efficient top entry or side entry (or combination) MVHR unit, capable of recovering over 85% of the wasted heat.

The unit is made from galvanised steel, white powder coated casing with 20 mm EPP insulation which provides a great level of air tightness, thermal efficiency and sound absorption. DV82 Entro-V has low energy EC fans with backward curved impellers that minimise the unit's energy consumption with a quiet operation and low specific fan power, achieving an 'A' energy efficiency.

The unit has an easy to clean and maintain plastic counterflow heat exchanger which prevents the air streams from mixing. In addition, the unit is designed with a double filter facility that comes with two ISO Coarse 55% (G4) filters as standard with an optional ISO ePM1 60% (F7) pollen filter which provides additional protection against invisible, harmful particles creating an ultra-hygienic environment. ISO ePM Coarse 55% (G4) and ISO ePM1 60% (F7) can be used in conjunction with each other on supply air side.





## TECHNICAL DATA

Specification	DV82 Entro-V
Air flow m <sup>3</sup> /h / l/s @100Pa	300 / 83.3
For dwelling floor area up to (m <sup>2</sup> )	184
Reference dwelling	4 / 5 bed house
Thermal efficiency	83 - 86%
Heat exchanger	Counterflow (Plastic)
SEC class	A
Electrical supply	230V / 1ph / 50Hz
Max power consumption	166 W
Sound level @ 3m (dB(A))	35 - 48
Specific Power Input (SPI) (W/(m <sup>3</sup> /h))	0.27
Fans	EC
Electric heater	2 x 83 W
IP classification	IP54
Weight (kg)	50
Dimensions (L x D x H) (mm)	580 x 530 x 795
Controls*	4-speed manual controller or optional digital controller
Duct diameter (mm)	160
Condensate discharge (mm)	1/2 inch BSP
Summer Bypass damper	100% Automatic
Frost protection	Yes
Filter class**	(G4) ISO Coarse 55%, optional (F7) ISO ePM1 60%
Optional BMS Connectivity	Communication through I2C-Modbus
Casing	Galvanised steel. Powder paint. (20 mm insulation)
Mounting	Wall, Floor
Orientation of unit	Right or Left-handed
Part no.	<b>90001244</b>

\*Controls purchased separately

\*\*Complies with ISO 16890

## DIMENSIONS

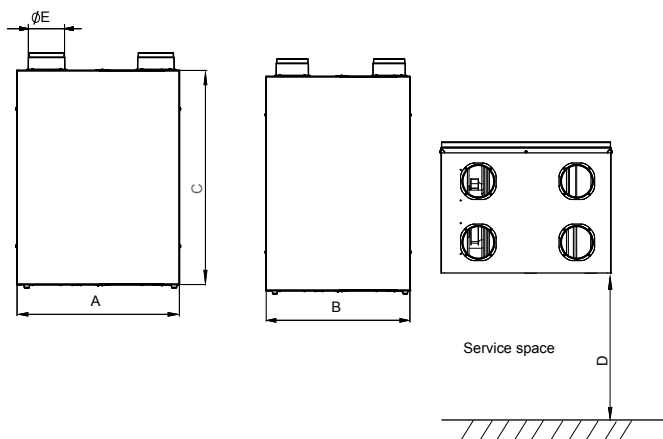

+ excludes motors. Motor warranty one year from date of purchase

Model	A	B	C	D	E
DV82	580	530	795	600	160

## PERFORMANCE

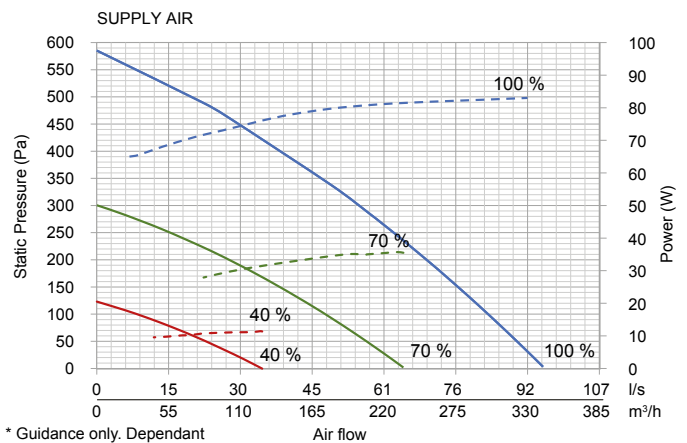

\* Guidance only. Dependant upon system pressure.

## SAP RESULTS

Tested by the BRE (Building Research Establishment) and eligible for the PCDB database. Systems with rigid ductwork only SAP 2005 results

Exhaust terminal configuration	Specific Fan Power (W/l/s)	Thermal efficiency (%)
Kitchen + 1 additional wet room	1.03	79
Kitchen + 2 additional wet rooms	0.89	79
Kitchen + 3 additional wet rooms	0.87	79
Kitchen + 4 additional wet rooms	0.91	80
Kitchen + 5 additional wet rooms	0.99	80
Kitchen + 6 additional wet rooms	1.10	80
Kitchen + 7 additional wet rooms	1.28	80

Systems with rigid ductwork only SAP 2012 results

Exhaust terminal configuration	Specific Fan Power (W/l/s)	Thermal efficiency (%)
Kitchen + 1 additional wet room	0.95	79
Kitchen + 2 additional wet rooms	0.92	80
Kitchen + 3 additional wet rooms	0.98	80
Kitchen + 4 additional wet rooms	1.13	80
Kitchen + 5 additional wet rooms	1.35	80
Kitchen + 6 additional wet rooms	1.64	80

## ACCESSORIES

The following options are available

Accessory	Product Code
Entro-V digital controller	90001299
Entro-V basic controller	90001308
DV82 Entro-V G4(ISO ePM Coarse 55%) filter	90001324
DV82 Entro-V F7(ISO ePM1 60%) filter	90001327
DV82 Entro-V heater 0,5 kW	90001335
DV82 Entro-V heater 1 kW	90001336
DV82 Entro-V heater 1,5 kW	90001337
DV82 Entro-V heater 2 kW	90001341

## ErP RATING

The DV82 Entro-V meets requirements set out by the Energy Related Products (ErP) Directive 2016, achieving an A rating. You can find out more about the ErP Directive and find the DV82 Fiche and Label at [www.airflow.com](http://www.airflow.com) Label 90001244

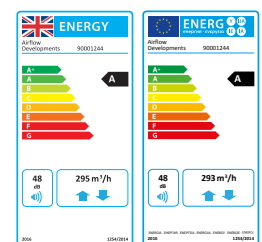

# EntroV DV82

## Mechanical Ventilation with Heat Recovery

### UNIT CONFIGURATION

The unit is supplied as a right-handed version as standard.

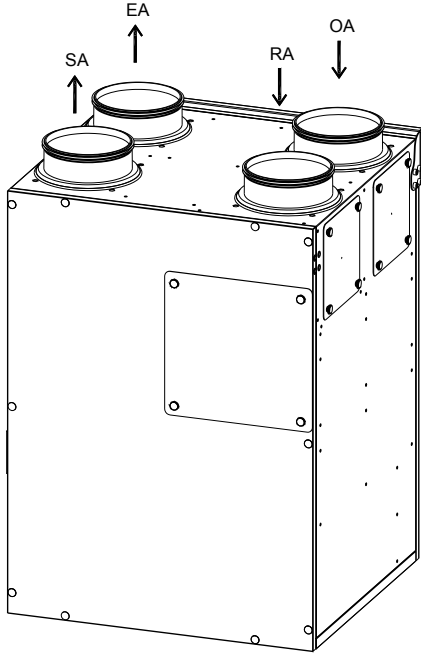

- OA** = Outside Air in
- SA** = Supply Air to habitable rooms
- RA** = Return Air from wet rooms
- EA** = Exhaust Air to outside

### HEAT EXCHANGER DIAGRAM

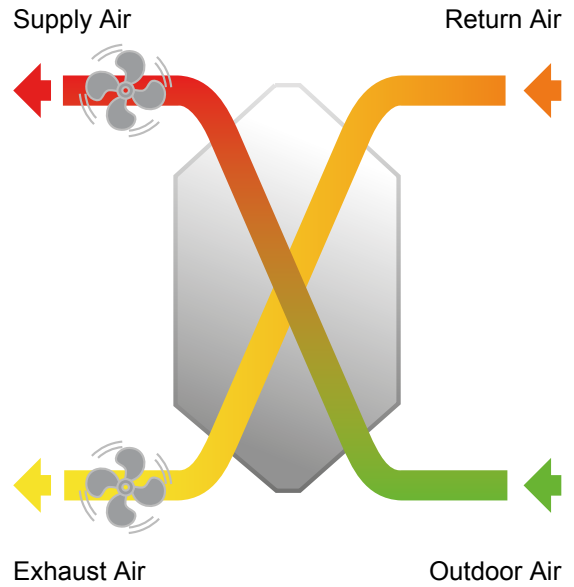

### INSTALLATION

The units can be installed in vertical mounting positions, on the wall or on the floor. Hanging brackets, screws and feet are supplied with the unit. Also, the unit has interchangeability of spigots position from top to the sides.

#### CHANGING THE SPIGOTS POSITION

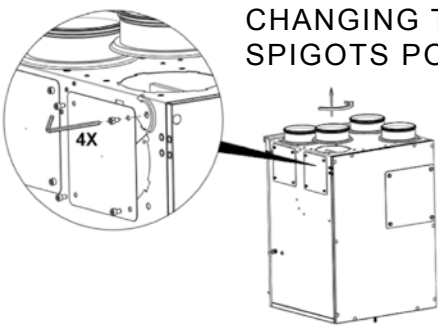

#### INSTALLATION ON THE WALL

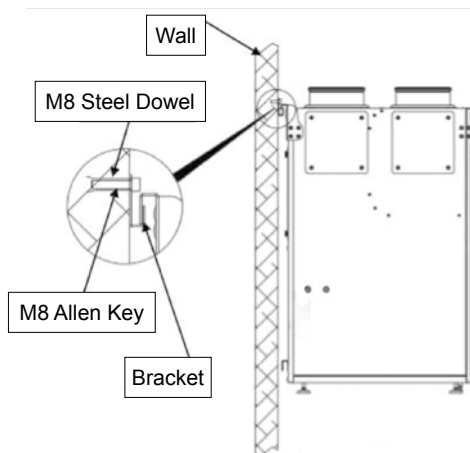

#### INSTALLATION ON THE FLOOR

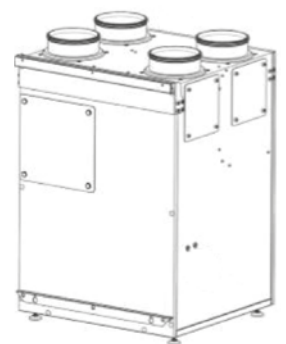





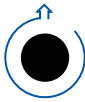

## CONTROL OPTIONS

The unit can be controlled by one of the following:

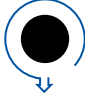
- Basic controller (supplied with the DV82 standard kit)
- Digital controller
- Modbus through a PC or a central automated unit
- Additional external sensors achieving on-demand ventilation
- Switched live signal from light/remote switches

### Basic controller user-interface

	<b>Low fan speed</b> e.g. background ventilation		<b>Control button to increase the fan speed</b>
	<b>Medium fan speed</b> e.g. everyday running rate		<b>Control button to decrease the fan speed</b>
	<b>High fan speed</b> e.g. when cooking or showering		<b>Filter reminder / Error display LED</b>
	<b>Boost</b> increased occupants in dwelling; purging the dwelling		

## BASIC CONTROL

The basic controller compatible with the DV82 Entro-V unit allows multiple standard functions such as:

- 4 fan speed control
- Boost function (normally the 4th speed)
- Free cooling via the by-pass actuator
- Frost protection based on input signals from humidity and temperature sensors
- Modbus function
- Faults indicator
- Filter maintenance reminder
- Fire alarm function (based on a signal received from the DI3 input on the PCB board, the unit will operate according to the set fire scenario)
- Child-proof protection locks/unlocks the buttons providing extra safety



### THE CONTENTS OF THE STANDARD KIT

One part number is all you need to quote



#### STANDARD KIT - PART No: 90001655

Part no	Product Description	Quantity
90001244	DUPLEXVENT DV82 ENTRO-V	1
90001308	ENTRO-V BASIC CONTROLLER	1
90000266	10-PORT DIST BOX (ROUND SPIGOTS)	2
9041130	75 MM X 50 M ROUND AIRFLEXPRO COIL*	2
9041132	75 MM CONNECTOR	2
9041133	75 MM PIPE SEALING RING (PACK OF 10)	4
51849404	150 MM / 6 IN ADJUSTABLE 60 - 325 MM CLAMP	4
90000250	78 MM 90° CEILING/WALL PLENUM	14
90000339	125 MM PLASTIC ADJUSTABLE SUPPLY VALVE	8
90000340	125 MM PLASTIC ADJUSTABLE EXTRACT VALVE	6
90000352	AIRFLEXPRO ROUND CLIPS PK10 (RED)	4
90000506	160 MM STAINLESS STEEL ROUND COWL WITH MESH	2
90000465	160 MM X 2 M ISO PIPE	4
90000466	160 MM 45° ISO PIPE BEND	3
90000467	160 MM 90° ISO PIPE BEND	5
90000468	160 MM ISO PIPE CONNECTOR PLASTIC	6

\*The red round AirflexPro rolls can be supplemented by blue round AirflexPro rolls. \*Red clips can also be supplemented by blue clips

#### OPTIONAL ACCESSORIES

Part no	Product Description
90001379	75 MM X 50 M ROUND AIRFLEXPRO COIL (BLUE)
90001381	75 MM AIRFLEXPRO FITTING CLIPS (BLUE)
90000255	20 M COIL ELLIPTICAL AIRFLEXPRO DUCTING (RED)
90000353	75 MM AIRFLEXPRO FITTING CLIPS (RED)
90001299	ENTRO-V DIGITAL CONTROLLER
90000499	REGAL 160 MM COWL WITH FRONT APERTURE
90000498	REGAL 160 MM COWL WITH SIDE APERTURE
90000126	FIRE PROTECTION VALVE (EXTRACT)
9041168	METAL ADJUSTABLE AIR VALVE (SUPPLY)
9041172	METAL ADJUSTABLE AIR VALVE (EXTRACT)
90000540	ON/OFF SWITCH
90000316	125 MM SQUARE SUPPLY/EXTRACT VALVE ADJUSTABLE, CLOSED FRONT WITH G2 FILTER
90000251	90° VERTICAL TRANSITION PIECE (ROUND-ELLIPTICAL)
90000252	STRAIGHT TRANSITION PIECE (ROUND-ELLIPTICAL)
90001327	ISO EPM1 60% (F7) POLLEN FILTER
90000259	ELLIPTICAL SPIGOT CONNECTION
90000249	CEILING OR WALL PLENUM ELLIPTICAL
9041177	160 X 1250 MM DUCT SOUND ATTENUATOR
90000645	160 MM X 1 M SEMI FLEXIBLE INSULATED ATTENUATOR
90000016	INSULATION SEALING TAPE 50 M

# Entro<sup>®</sup>V DV82

Mechanical Ventilation with Heat Recovery

## Entro-V DV82 Kit



Shrink wrap ready to be delivered

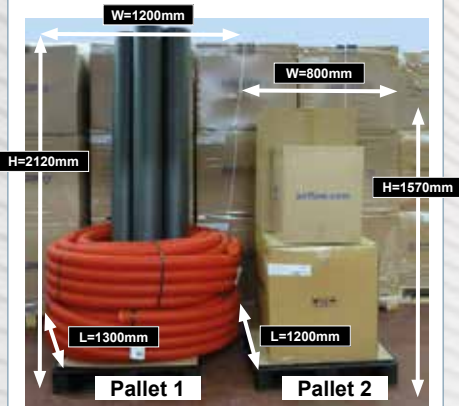

All components inside the red ducting coils

## Entro-V DV65 Kit contents



Complete contents of Entro-V DV82 Kit ready to fit

Dimensions (mm)	Pallet 1	Pallet 2
Height (includes the pallet height) (mm)	2120	1570
Length (mm)	1300	1200
Width (mm)	1200	800
Weight of products (kg)	35.2	88.69
Weight of products + pallet (kg)	42	95.49

Supply and extract air to and from rooms is done through anti-static smooth bore, hygienically lined AirflexPro ducting. Ensuring minimal in-duct airflow noise and dirt accumulation, it is supplied economically straight from the roll.

The durable, ribbed outer skin of AirflexPro offers excellent flexibility, strength and compressibility, up to 10 kN / m<sup>2</sup>. These properties make it ideally suited for embedding straight into concrete screed without distortion, which ensures predicted airflow rates through ducts are maintained.

### AIRFLEXPRO – MOVING AIR EFFICIENTLY AND EFFECTIVELY.

AirflexPro is an air ducting system, when used in conjunction with a Mechanical Heat Recovery Unit

(MVHR) it provides a total ventilation system for dwellings.

AirflexPro is a radial ducting system offering advantages over the more traditional branch systems. AirflexPro is suited to new build but can also be used in the retrofit market and can be combined with such technologies as coanda valves. The system has zero leakage and low system pressure, therefore making it a very efficient air movement system.



# ZERO LEAKAGE SEMI RIGID DUCTING



Due to its flexible properties, the AirflexPro ducting can be installed easily and cost-effectively directly from the roll.

It has an anti-static and hygienic lining to help prevent dust and bacterial build up. When combining the install project cost with the components of a traditional branch duct system, AirflexPro with its quicker install and better quality components is better value for money.



## AIRFLEXPRO = ENERGY SAVING

It makes no sense to invest in an energy efficient MVHR unit to improve well-being and indoor air quality when the energy saving benefits to be gained are lost through leakage from traditional branch ducting systems.

## TRADITIONAL DUCTING = ENERGY LOSS

An efficient MVHR unit is only as good as its air distribution system. Traditional duct systems have numerous joints all of which are prone to leakage. Leaking duct systems are inefficient and waste energy, as a proportion of the air never reaches its destination.

Flexible and rigid branch systems can result in restricted airflows and higher system resistances. They can also transmit sound throughout the ducting causing unwanted and nuisance noise in other rooms.

Poor duct installation also costs money. Overcoming a leaky duct system means the MVHR unit will have to run at a higher speed to give the required airflow rates in the correct areas of the property. Badly designed duct systems, or systems that do not follow the designed route, will have higher system pressures. In extreme cases an MVHR unit sized correctly for a dwelling will not be able to cope with the extra demand created by the additional pressures. AirflexPro is a highly flexible, efficient and easy to install ducting system which eliminates these problems.

## FEATURES



# Adroit<sup>®</sup>

Smart Ventilation with Heat Recovery  
Take control, at Home or “On the Go”

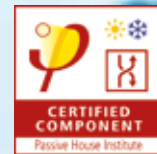

## Alternative premium models to upgrade to

- Nine models
- Over 90% heat recovery
- Comes with 3 filters
- Integrated CO<sup>2</sup> sensor
- Integrated humidity sensor
- Internet enabled
- Passive House approved

## CONTENTS INCLUDED IN KIT

### Ceiling or Wall Plenum Round

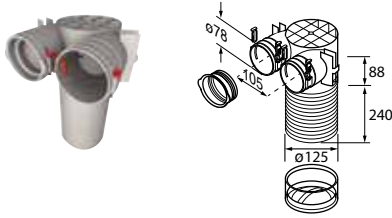

**Part Number - 90000250**

75 mm 90° Ceiling / Wall Plenum  
Connects AirflexPro Round through the ceiling to the extract / supply valve. Can be cut down for varying height of void.

### Straight Connection



**Part Number - 9041132**

Connects AirflexPro round to AirflexPro round.

### Sealing Rings Round



**Part Number - 9041133**

75 mm dia. AirflexPro  
Round Sealing Ring (pack of 10).

### Plastic Adjustable Air Valve (Supply)

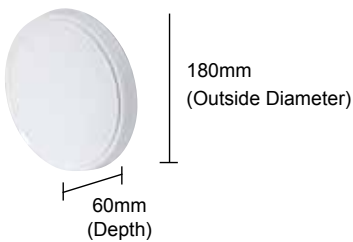

**Part Number - 90000339**

ø125 mm Directional supply  
Direct the airflow from this adjustable and lockable supply valve to any area in the room.

### Round Cowl with Mesh

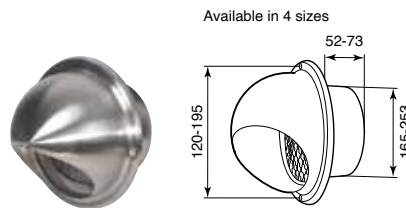

**Part Number - 90000506**

ø160 mm  
A weather-resistant stainless steel round cowl with louvres suitable for air intake or discharge. To be used with a 160 mm diameter connection.

The cowl features a mesh / bird screen providing suitable protection against birds and pests and is very easy to install offering you a high-quality, no-hassle solution with an attractive finish.

**KEY FEATURES:**

Stainless steel construction for wall mounting.

Provides protection against pests.

Suitable for both supply and exhaust air.

### 10-Port Distribution Box (round)

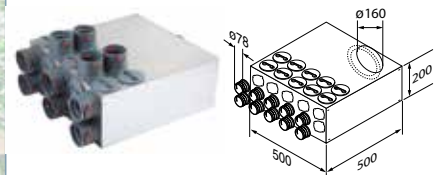

**Part Number - 90000266**

AirflexPro distribution boxes are the primary component in the quiet, effective distribution of supply and extract air, to and from the central MVHR unit. They can be configured for in-line, 90° angle, and side-on connection so that they integrate into any building layout enabling smooth easy access to connect to round and elliptical ducting. Available from 5 to 15 duct connection ports, depending on the system design and for full flexibility, it is supplied with fixing brackets and screws. They are fully insulated to retain warm air energy and acoustically lined to absorb airborne noise. Unused ports should be sealed with blanking caps. Constructed from durable steel they are tough for on-site handling and incorporate an access door enabling routine internal cleaning and maintenance. Each connection port has a keyway indicator mark to easily align round and elliptical duct connectors during the installation process.

### Plastic Adjustable Air Valve (Extract)

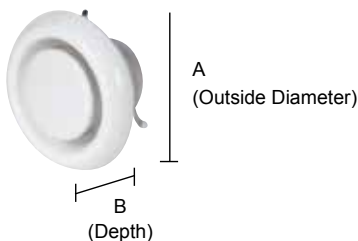

**Part Number - 90000340**

ø125 mm (A 165 x B 65 mm)  
White plastic lockable extract valve.



### ISO Pipe (Internal Connection)

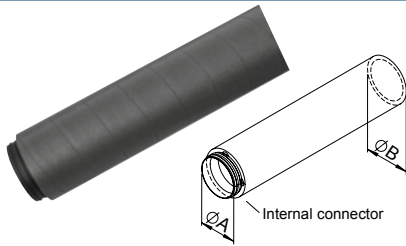

**Part Number - 90000465**

ø160 x 2000 mm - A 160 mm B 192 mm

Comes with internal plastic connector.

Pre-insulated one-piece

Quick and easy assembly

Tough, durable, anti-static EPP

Fire retardant to B2

Avoids condensation build-up

Sound-absorbing, smooth bore pipe

Choice of components to suit any layout

#### SPECIFICATIONS

Thickness: 15 mm

Material density: 60g/dm<sup>3</sup>, antistatic

Thermal conductivity: 0.042 W / mK

Application range: -25 °C to +80 °

Elasticity: 30% DIN 52612

### ISO 90° Degree Elbow

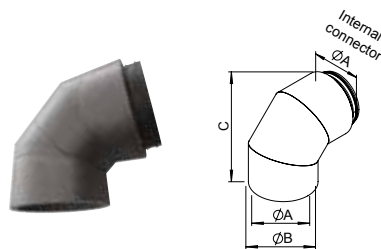

**Part Number - 90000467**

ø160 mm - A 160 mm B 192 mm C 272 mm

Comes with internal plastic connector.

See specifications of part number - 90000465

### ISO 45° Degree Elbow

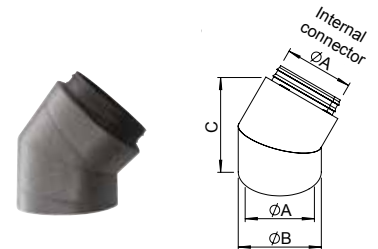

**Part Number - 90000466**

ø160 mm - A 160 mm B 192 mm C 242 mm

Comes with internal plastic connector.

See specifications of part number - 90000465

### ISO Pipe

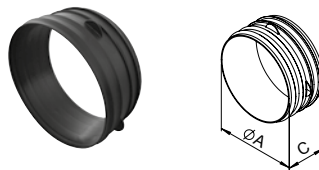

**Part Number - 90000468**

ø160 mm - A 160 mm C 80 mm

Internal plastic connector for ISO pipes.

### Worm Drive Clip



**Part Number - 51849404**

ø150 mm/ 6" adjustable  
60 mm - 325 mm 8 mm wide

### AirflexPro ducting - for air distribution system



**Product Number - 9041130**

AirflexPro round



**Product Number - 90000352**

AirflexPro duct clips

**OPTIONAL ACCESSORIES**

**AirflexPro ducting - for air distribution system (blue)**



**Product Number - 90001379**  
AirflexPro round



**Product Number - 90001381**  
AirflexPro duct clips

**AirflexPro Elliptical ducting - for air distribution system**



**Product Number - 90000255**  
20 m coil (elliptical) 51 mm x 115 mm



**Product Number - 90000353**  
AirflexPro elliptical duct clips

**Digital controller**



**Part Number - 90001299**  
Optional separate fan controller for ease of commissioning

**Regal Front Entry Cowl**



**Part Number - 90000499**  
To suit ø160 mm ISO duct  
A 265 mm D 97 mm C 240 mm

**Regal Side Entry Cowl**

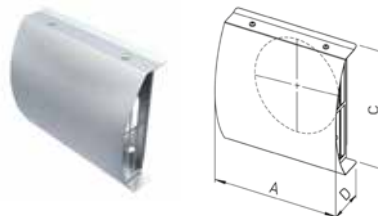

**Part Number - 90000498**  
To suit ø160 mm ISO duct  
A 265 mm D 97 mm C 240 mm

**Fire Protection Valve (Extract)**



**Part Number - 90000126**  
ø125 mm  
White powder coated, metal, lockable valve with thermal fuse safety feature.

**Metal Adjustable Air Valve (Supply)**



**Part Number - 9041168**  
ø125 mm  
White powder coated lockable supply valve.

**Metal Adjustable Air Valve (Extract)**



**Part Number - 9041172**  
ø125 mm  
White powder coated lockable extract valve.

**Stylish Supply / Extract Valve**

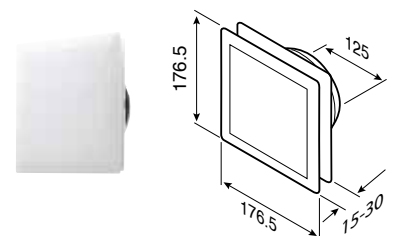

**Part number - 90000316**  
ø125 mm Square supply / extract adjustable valve with filter.

## OPTIONAL ACCESSORIES

### On / off Switch



**Part Number - 90000540**

Single pole

### 90° Vertical Transition Piece

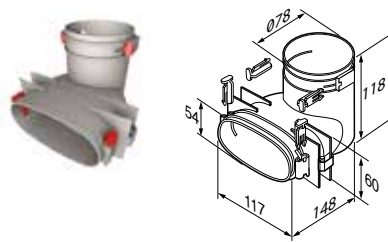

**Part Number - 90000251**

90° Vertical Transition Piece  
(round-elliptical)

### Straight Connection Piece

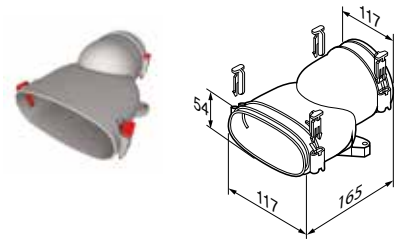

**Part Number - 90000252**

Straight Transition Piece  
(round-elliptical)

### F7 Pollen Filter



**Part Number - 90001324**

ISO ePM1 60% (F7) pollen filter  
Additional filter to reduce the ingress of pollen into the home. Used in conjunction with existing filter.

### Elliptical Spigot Connection

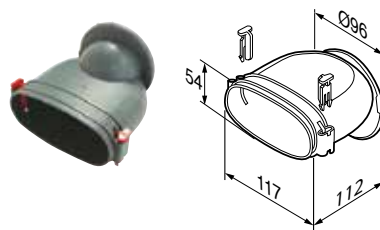

**Part Number - 90000259**

Elliptical Spigots for  
Distribution Boxes

### Ceiling or Wall Plenum Elliptical

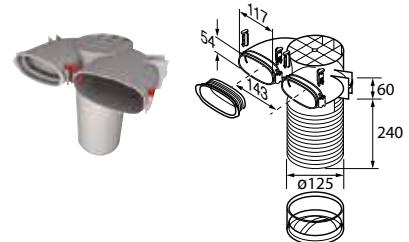

**Part Number - 90000249**

54 x 117 mm 90°  
Ceiling / Wall Plenum

### Duct Sound Attenuator

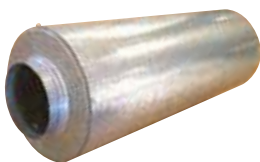

**Part Number - 9041177**

ø160 x 1250 mm

Complete with air tight seals. Made from durable galvanised steel.

### Semi-flexible Insulated Attenuator



**Part Number - 90000645**

ø160 x 1 m length

Helps reduce noise ingress.  
Helps connect two miss aligned ducts.  
Insulated to reduce energy loss.

### Insulation Sealing tape



**Part Number - 90000016**

50 mm width x 50 m length

Aluminium tape for use with various insulation materials.



Choosing Entro-V MVHR unit means you are investing in the quality of your indoor air and your family's health and well-being.

Entro-V will help you create a home to nurture and grow your family in an environment they can thrive in.

The Entro-V unit will deliver many years of high quality performance and service for you and your home.



## FIELD SUPPORT



At Airflow we do not view any of our customers a short term agreement. We believe that by working together in partnership we can achieve better results in realising our shared objectives to deliver efficient, effective and reliable ventilation solutions.

Our knowledgeable, trained technicians can provide support to ensure your ventilation project runs smoothly and where issues arise, they can advise on the most suitable course of action to provide a successful outcome.

Airflow offers full field support across the UK and are supported by an internal technical team offering help and support for any issues or queries.



## CONTACT US



### **Airflow Developments Limited**

Tel: 01494 525252  
e-mail: [info@airflow.com](mailto:info@airflow.com)

### **Customer Services**

Tel: 01494 560800  
e-mail: [customer\\_services@airflow.com](mailto:customer_services@airflow.com)

### **Technical Support**

Tel: 01494 560950  
e-mail: [technical\\_support@airflow.com](mailto:technical_support@airflow.com)

### **Airflow Developments Limited**

Aidelle House, Lancaster Road,  
Cressex Business Park,  
High Wycombe, Buckinghamshire,  
United Kingdom, HP12 3QP

Registered company 550374

[airflow.com](http://airflow.com)

### **Also Available Through**



### **Connect With Us!**



AirflowD



AirflowDevelopments1



AirflowD



airflowdevelopmentsLtd



Airflow Developments



Airflow Developments



**UNITED KINGDOM (head office)**

**Airflow Developments Limited**  
Aidelle House, Lancaster Road  
Cressex Business Park  
High Wycombe, Bucks. HP12 3QP.

Tel: +44 (0) 1494 525252  
Email: [info@airflow.com](mailto:info@airflow.com)  
Web: [airflow.com](http://airflow.com)

**GERMANY**

**Airflow Lufttechnik GmbH**  
Postfach 1208  
D-53349  
Rheinbach, Germany

Tel: +49 (0) 2226 92050  
Email: [info@airflow.de](mailto:info@airflow.de)  
Web: [airflow.de](http://airflow.de)

**CZECH REPUBLIC**

**Airflow Lufttechnik - Praha**  
Hostynska 520  
10800 Praha 10  
Prague, Czech Republic

Tel: +42 (0) 2747 72230  
Email: [info@airflow.cz](mailto:info@airflow.cz)  
Web: [airflow.cz](http://airflow.cz)